

# CYCLONE<sup>®</sup>

Roof Penetration Housings, LLC

## INSTALLATION INSTRUCTIONS

### For Cyclone CRH-40x32 Roof Hatch

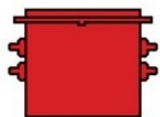
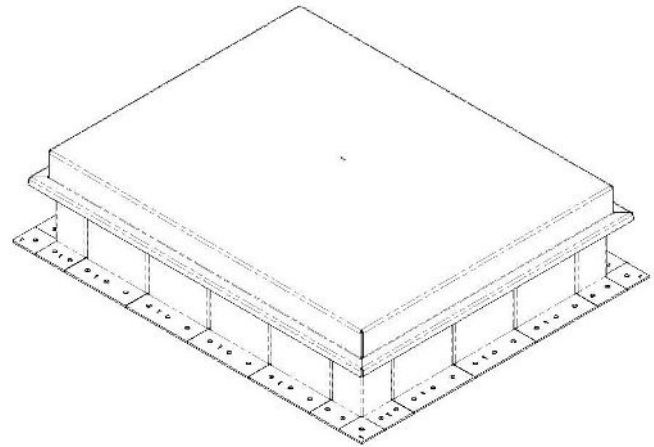
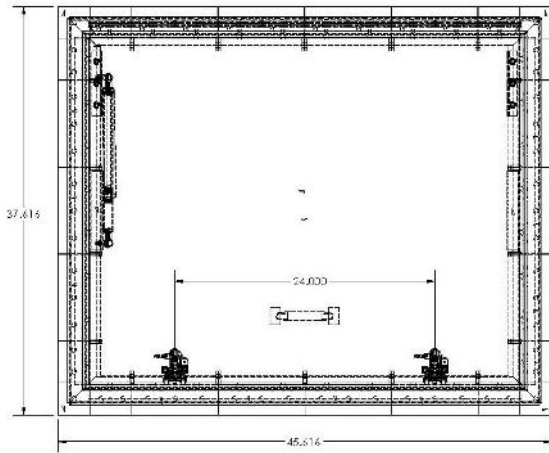

# RPH

Roof Penetration Housings, LLC

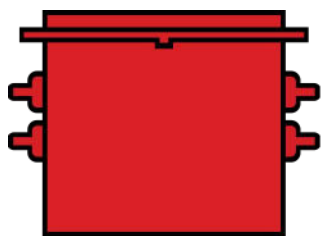

# CYCLONE<sup>®</sup>

Roof Penetration Housings, LLC

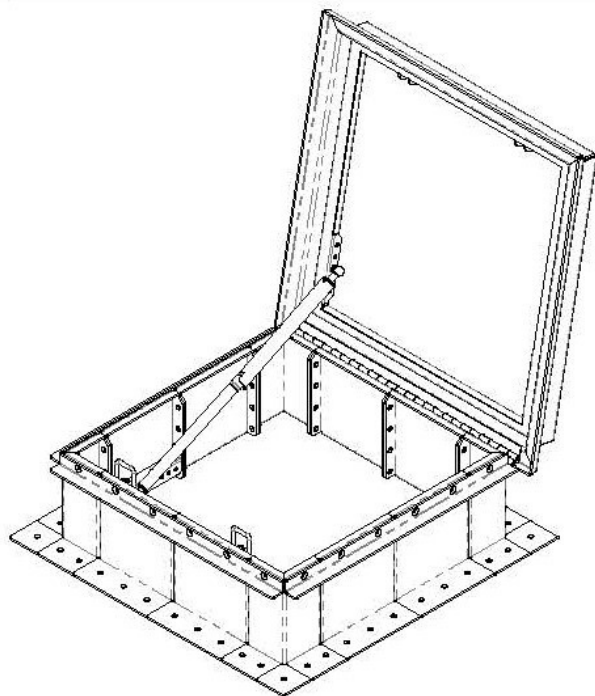

1. Place the roof hatch over the opening in the roof. The roof rough opening dimensions are equal to hatch dimensions as measured from the inside curb to inside curb.
2. The roof hatch curb flange comes with mounting holes . Mark the pre-drilled diameter holes from the mounting flange through the roof deck or a concrete curb. Drill for installation of anchors or other fasteners (provided by others). Bolt or otherwise fasten roof hatch curb flange to roof deck.
3. Install roofing material up to and surrounding the roof curb, Lap and seal all joints in roofing material to provide a weather-tight seal.

Vault<sup>®</sup> CYCLONE with the 10 year insured warranty,

ICC-500 (2014) and FEMA 361 (2015) Tornado Protocol 4

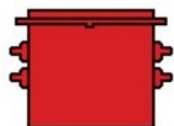

## RPH

Roof Penetration Housings, LLC

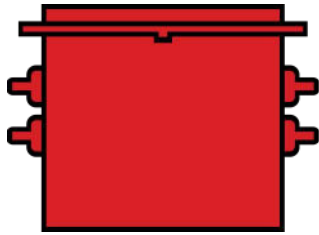

**CYCLONE**<sup>®</sup>  
Roof Penetration Housings, LLC

## IMPORTANT INFORMATION

Part B 1.2.3 The ICC 500 now requires **all impact protective systems to have a label indicating that they have passed testing and comply with the standard.**

Reference: ICC500 Sec 107.3.3 While contractors should not be held responsible for whether components manufactured by others meet safe room criteria, they should be held responsible for purchasing and installing components that are consistent with the contract documents and instructions provided by the manufacturer so that they provide the appropriate level of protection.

Both ICC 500 and FEMA P-361 (no higher criteria for testing) require that impact protective systems be tested in accordance with Chapter 8 (specifically, Section 804.9.6). Please note that the term 'systems' means the entire assembly, so testing individual components of the assembly does not meet the testing requirements.

**The fully assembled system must be tested.**

Since the 2009 edition of the International Building Code, Section 423 (Section 323 of International Residential Code) has required that **storm shelters be constructed in accordance with ICC 500. Regardless of the Building Code adopted in the jurisdiction where constructed or installed, all FEMA-funded safe rooms must meet the minimum requirements of ICC 500 and FEMA P-361.**



**RPH**  
Roof Penetration Housings, LLC